

جدول میله گرد آرماتور

d mm	محیط cm	وزن kg/m	سطر اول سطح مقطع میله گرد است که در ۱ و ۲ و ۳ ... ضرب شده است. سطر دوم مقطع میله گرد است که در ۱۵X۱ و ۱۵X۲ و ۱۵X۳ ... ضرب شده است.																d mm
			1	2	3	4	5	6	7	8	9	10	11	12	13	14	15	16	
6	1.89	0.222	0.28 4.24	0.57 8.48	0.85 12.72	1.13 16.96	1.41 21.21	1.70 25.45	1.98 29.69	2.26 33.93	2.55 38.17	2.83 42.41	3.11 46.65	3.39 50.89	3.68 55.13	3.96 59.38	4.24 63.62	4.52 67.86	6
8	2.51	0.395	0.50 7.54	1.01 15.08	1.51 22.62	2.01 30.16	2.51 37.70	3.02 45.24	3.52 52.78	4.02 60.32	4.52 67.86	5.03 75.40	5.53 82.94	6.03 90.48	6.54 98.02	7.04 105.56	7.54 113.10	8.04 120.64	8
10	3.14	0.617	0.79 11.78	1.57 23.56	2.36 35.34	3.14 47.12	3.93 58.91	4.71 70.69	5.50 82.47	6.28 94.25	7.07 106.03	7.85 117.81	8.64 129.59	9.43 141.37	10.21 153.15	11.00 164.93	11.78 176.72	12.57 188.50	10
12	3.77	0.888	1.13 16.97	2.26 33.93	3.39 50.90	4.52 67.86	5.66 84.83	6.79 101.79	7.92 118.76	9.05 135.72	10.18 152.69	11.31 169.63	12.44 186.62	13.57 203.58	14.70 220.55	15.83 237.51	16.97 254.48	18.10 271.44	12
14	4.40	1.208	1.51 23.09	3.08 46.18	4.62 69.27	6.16 92.36	7.70 115.46	9.24 138.55	10.78 161.64	12.32 184.73	13.88 207.82	15.39 230.91	16.93 254.00	18.47 277.09	20.01 300.18	21.55 323.27	23.09 346.37	24.63 369.46	14
16	5.03	1.578	2.01 30.16	4.02 60.32	6.03 90.48	8.04 120.64	10.05 150.80	12.06 180.95	14.07 211.11	16.09 241.27	18.10 271.43	20.11 301.59	22.2 331.75	24.13 361.91	26.14 392.07	28.15 422.23	30.16 452.39	32.17 482.54	16
18	5.66	1.998	2.55 36.17	5.09 76.34	7.63 114.51	10.18 152.68	12.72 190.85	15.27 229.02	17.81 267.19	20.36 305.36	22.90 343.54	25.45 381.71	27.99 419.88	30.54 458.05	33.08 496.22	35.63 534.39	38.17 572.56	40.72 610.73	18
20	6.28	2.466	3.14 47.12	6.28 94.25	9.43 141.37	12.57 188.50	15.71 235.62	18.85 282.74	21.99 329.87	25.13 376.99	28.27 424.12	31.42 471.24	34.56 518.36	37.70 565.49	40.84 612.61	43.96 659.74	46.12 706.86	50.27 753.98	20
22	6.91	2.984	3.86 57.02	7.60 114.04	11.40 171.06	15.21 228.08	19.01 285.10	22.81 342.12	26.61 399.14	30.41 456.16	34.21 513.18	38.01 570.20	41.81 627.22	45.62 684.23	49.42 741.25	53.22 798.27	57.02 855.29	60.82 912.31	22
24	7.54	3.551	4.52 67.86	9.05 135.72	13.57 203.56	18.10 271.43	22.62 339.29	27.14 407.15	31.67 475.01	36.19 542.87	40.77 610.73	45.24 678.59	49.76 746.44	54.29 814.30	58.81 882.16	63.34 950.02	67.86 1017.88	72.38 1085.74	24
26	8.17	4.168	5.31 79.64	10.62 159.28	15.93 238.92	21.24 318.56	26.55 398.20	31.86 477.84	37.17 557.48	42.47 637.12	47.78 716.76	53.09 796.40	58.40 876.04	63.71 955.67	69.02 1035.31	74.33 1114.95	79.64 1194.59	84.95 1274.23	26
28	8.80	4.834	6.16 92.36	12.32 184.73	18.74 277.09	24.63 369.45	30.79 461.81	36.95 554.18	43.10 646.54	49.26 738.90	55.42 831.26	61.58 923.63	67.73 1015.89	73.89 1108.05	80.05 1200.71	86.21 1293.08	92.36 1385.44	98.52 1477.80	28
30	9.43	5.549	7.07 106.03	14.14 212.06	21.21 318.09	28.27 424.12	35.34 530.15	42.41 636.17	49.48 742.20	56.55 848.23	63.62 954.26	70.69 1060.29	77.78 1166.32	84.82 1272.35	91.89 1378.38	98.96 1484.41	106.03 1590.44	113.10 1696.46	30
32	10.05	6.313	8.04 120.64	16.09 241.28	24.13 361.91	32.17 482.55	40.21 603.19	48.26 723.83	56.30 844.46	64.34 965.10	72.38 1085.74	80.43 1206.38	88.47 1327.01	96.51 1447.65	104.35 1568.29	112.60 1688.93	120.54 1809.56	128.68 1896.20	32
34	10.68	7.127	9.08 136.19	18.16 272.38	27.24 408.56	36.32 544.75	45.40 680.94	54.48 817.13	63.55 953.32	72.63 1089.50	81.71 1225.69	90.79 1361.88	99.87 1498.07	108.95 1634.26	118.03 1770.44	127.11 1906.63	136.19 2042.82	145.27 2179.01	34
36	11.31	7.990	10.18 152.68	20.36 305.36	30.54 458.05	40.72 610.73	50.89 763.41	61.07 916.09	71.25 1068.77	81.43 1221.46	91.61 1374.14	101.79 1526.82	111.97 1679.50	122.15 1832.18	132.32 1984.87	142.50 2137.55	152.68 2290.23	162.58 2442.91	36
38	11.94	8.903	11.34 170.12	22.68 340.23	34.02 510.35	45.36 680.47	56.71 850.58	68.05 1020.70	79.39 1190.82	90.73 1360.93	102.07 1531.05	113.41 1701.17	124.75 1871.28	136.09 2041.40	147.43 2211.52	158.78 2381.63	170.12 2551.75	181.46 2721.86	38
40	12.57	9.865	12.57 188.50	25.13 376.99	37.70 565.49	50.27 753.98	62.83 942.48	75.40 1130.98	87.97 1319.47	100.53 1507.97	113.10 1696.46	125.66 1884.96	138.23 2073.46	150.80 2261.95	163.36 2450.45	175.93 2638.94	188.50 2927.44	201.06 3015.94	40

صفحات تقسیم فشار

توضیح :

ارقام در داخل جدول مقادیر b_1 و b_2 می باشند.

ارقام سه سطر بالا، هر مقدار p بترتیب مربوط است به:

$$\sigma_s = 1600 \text{ kg/cm}^2$$

$$\sigma_s = 1800 \text{ kg/cm}^2$$

$$\sigma_s = 2400 \text{ kg/cm}^2$$

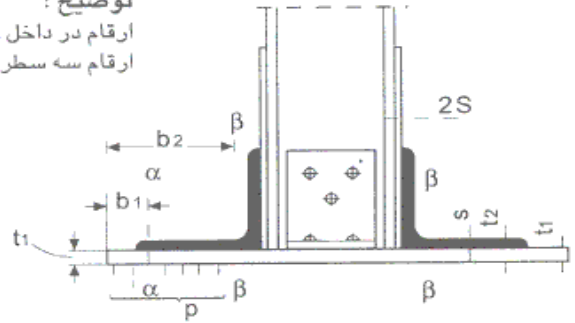
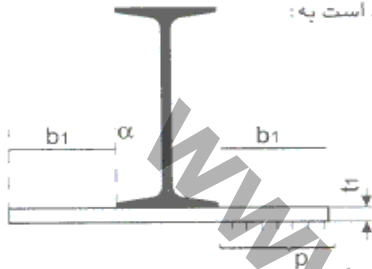

t_1, t_2 mm	12	14	15	16	18	20	22	24	25	26	28	30	35	40	45	50
3	160	187	200	213	240	267	293	320	333	347	373	400	467	533	600	667
	170	196	212	226	255	283	311	339	354	368	396	424	495	566	636	707
	196	229	245	261	294	327	359	392	408	425	457	490	572	653	735	816
4	139	162	173	185	208	231	254	277	289	300	323	346	404	462	520	577
	147	171	184	196	220	245	269	294	306	318	343	367	429	490	551	612
	170	198	212	226	255	283	311	339	354	368	396	424	495	566	636	707
5	124	145	155	165	186	207	227	248	258	269	289	310	361	413	465	516
	131	153	164	175	197	219	241	263	274	285	307	329	383	438	493	548
	152	177	190	202	226	253	278	304	316	329	354	379	443	506	569	632
6	113	132	141	151	170	189	207	226	236	245	264	283	330	377	424	471
	120	140	150	160	180	200	220	240	250	260	280	300	350	400	450	500
	139	162	173	185	208	231	254	277	289	300	323	346	404	462	520	577
7	105	122	131	140	157	175	192	209	218	227	244	262	306	349	393	436
	111	130	139	148	167	185	204	222	231	241	259	278	324	370	417	463
	128	150	160	171	192	214	235	257	267	278	299	321	374	428	481	535
8	98	114	122	131	147	163	180	196	204	212	229	245	286	327	367	406
	104	121	130	139	156	173	191	208	217	225	242	260	303	346	390	433
	120	140	150	160	180	200	220	240	250	260	280	300	350	400	450	500
9	92	108	115	123	139	154	169	185	192	200	216	231	269	308	346	395
	98	114	122	131	147	163	180	196	204	212	229	245	286	327	367	408
	113	132	141	151	170	189	207	226	236	245	264	283	330	377	424	471
10	88	102	110	117	131	146	161	175	183	190	204	219	255	292	329	365
	93	108	116	124	139	155	170	186	194	201	217	232	271	310	349	387
	107	125	134	143	161	179	197	215	224	233	250	268	313	358	402	447
12	80	93	100	107	120	133	147	160	167	173	197	200	233	267	300	333
	85	99	106	113	127	141	156	170	177	184	198	212	247	293	318	354
	98	114	122	131	147	163	180	196	204	212	229	245	286	327	367	408
16	69	81	87	92	104	115	127	139	144	150	162	173	202	231	260	299
	73	86	92	98	110	112	135	147	153	159	171	184	214	245	276	306
	85	99	106	113	127	141	156	170	177	184	198	212	247	283	318	354
22	59	69	74	79	89	98	108	118	123	128	138	148	172	197	222	246
	63	73	78	84	94	104	115	125	131	136	146	157	183	209	235	261
	72	94	90	96	109	121	133	145	151	157	169	181	211	241	271	302
30	51	63	67	72	81	89	98	107	112	116	125	134	157	179	201	224
	54	63	67	72	80	89	98	107	112	116	125	134	157	179	201	224
	62	72	77	83	93	103	114	124	129	134	145	155	181	207	232	258
40	44	54	58	63	71	79	87	95	100	104	112	120	144	166	188	210
	46	54	58	63	70	77	85	93	97	101	108	116	136	156	174	194
	54	63	67	72	80	89	96	107	112	116	125	134	156	179	201	224
50	39	46	49	52	59	65	72	78	82	85	91	98	114	131	147	163
	42	46	52	55	62	69	76	83	87	90	97	104	121	139	156	173
	48	56	60	64	72	80	88	96	100	104	112	120	140	160	180	200

عکس العمل از پایین به بالا در زیر صفحه فشار بر حسب کیلوگرم به سانتیمتر مربع $a =$



CAST INP

تیر آهن معمولی لانه زنبوری شده

IPA	H cm	S cm	t cm	a-a			b-b		
				F cm ²	Ix cm ⁴	Wx cm ³	F cm ²	Ix cm ⁴	Wx cm ³
14	20	0.57	0.86	21.62	1319	131	14.78	1237	123
	21			22.19	1479	140	14.21	1349	126
	22			22.76	1651	150	13.64	1456	132
16	22	0.63	0.95	26.56	1967	178	19.02	1876	170
	23			27.21	2184	189	18.39	2040	177
	24			27.84	2414	201	17.76	2199	183
18	25	0.69	1.04	28.47	2658	212	17.13	2352	188
	26			32.73	3119	249	23.07	2961	236
	27			33.42	3420	263	22.38	3184	244
20	28	0.75	1.13	34.11	3738	276	21.69	3402	252
	29			34.80	4072	290	21.00	3612	258
	30			37.90	3954	304	26.90	3848	295
22	31	0.81	1.22	39.40	4706	336	27.40	4450	317
	32			40.90	5337	369	25.90	5037	336
	33			42.40	6450	403	24.40	5566	349
24	34	0.87	1.31	45.98	6318	421	33.02	6041	402
	35			47.60	7354	459	31.40	6614	425
	36			48.41	7908	479	30.58	7189	435
26	37	0.94	1.41	50.03	9089	519	28.97	7902	451
	38			53.06	8820	520	39.44	8028	501
	39			54.20	9598	564	37.40	9015	530
28	40	1.01	1.52	56.54	10976	609	35.66	9978	554
	41			58.28	12475	656	33.92	10884	572
	42			59.88	10017	607	46.72	9902	594
30	43	1.08	1.62	62.70	12290	682	43.90	11663	647
	44			65.52	14845	761	41.08	13468	690
	45			68.34	17695	842	38.26	15128	720
32	46	1.15	1.73	71.1	15518	816	50.9	14844	781
	47			73.1	17515	873	48.9	16351	817
	48			75.1	19657	926	46.9	17809	848
34	49	1.22	1.83	78.2	23154	1029	43.8	19845	882
	50			79.8	19234	961	58.2	18514	925
	51			81.9	21583	1027	56.1	20336	960
36	52	1.30	1.95	85.2	25414	1129	52.8	22984	1021
	53			88.4	29628	1234	49.6	25429	1058
	54			89.2	23688	1128	66.2	22921	1091
38	55	1.37	2.05	93.8	29376	1277	61.6	27272	1165
	56			96.1	32499	1354	59.3	29358	1223
	57			100.7	39326	1512	54.7	33192	1276
40	58	1.44	2.16	100.1	30337	1348	73.3	29254	1300
	59			106.2	38945	1557	67.2	35613	1424
	60			107.4	40823	1600	66.0	36827	1444
42	61	1.52	2.28	112.3	48880	1777	61.1	41348	1503
	62			110.0	34903	1517	84.0	34036	1479
	63			115.2	42524	1700	78.3	40145	1605
44	64	1.60	2.40	120.4	51066	1691	73.6	45011	1704
	65			125.6	60572	2068	68.4	51343	1770
	66			123.4	45843	1833	90.6	44264	1770
46	67	1.68	2.52	128.9	55037	2038	85.1	51295	1699
	68			133.0	62606	2196	81.0	56341	1976
	69			137.1	70776	2359	76.9	61050	2035
48	70	1.76	2.64	139.6	61962	2253	96.4	58722	2135
	71			143.9	70319	2424	92.1	64720	2231
	72			146.8	76249	2541	89.2	68569	2285
50	73	1.84	2.76	154.0	92372	2842	82.0	77372	2380
	74								

www.PDFADAN.com

+98 216629944

www.PDFADAN.com

CAST IPB

تیر آهن پال پهن لانه زنبوری شده

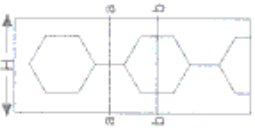

IPA	H cm	S cm	t cm	a-a			b-b		
				F cm ²	I _x cm ⁴	W _x cm ³	F cm ²	I _x cm ⁴	W _x cm ³
10	15	0.60	1.0	29.0	1140	152	23.0	1090	145
12	18	0.65	1.1	37.9	21172	241	30.1	2073	230
14	20	0.70	1.2	47.2	3385	338	38.8	3284	328
	21			47.9	3778	359	38.1	3617	344
	22			48.5	4195	381	37.4	3956	358
	23			59.1	5117	465	48.5	5001	454
	24			59.9	5655	491	48.7	5472	475
16	24	0.80	1.3	60.7	6224	518	47.9	5950	495
	25			61.5	8824	545	47.1	6435	514
	25			71.3	8028	642	59.3	7833	626
	26			72.1	8767	674	58.5	8476	652
18	27	0.85	1.4	73.0	9541	706	57.6	9127	676
	28			73.8	10353	739	56.8	9786	699
	28			83.5	10271	790	72.7	10141	780
	28			85.3	12123	865	70.9	11816	843
20	30	0.90	1.5	87.1	14147	943	69.1	13547	903
	32			88.9	16345	1021	67.3	15308	956
	30			98.6	10210	1080	83.4	15885	1059
	32			100.5	18724	1170	81.5	15090	1130
22	33	0.95	1.6	101.5	20056	1215	80.5	19213	1164
	35			103.4	22672	1306	78.6	21480	1227
	32			114.0	21430	1339	98.0	21088	1318
	34			116.0	24533	1443	96.0	23866	1403
24	36	1.00	1.7	116.0	27867	1548	94.0	26715	1484
	38			120.0	31438	1654	92.0	29608	1558
	33			125.0	25356	1597	111.0	25139	1523
	36			128.0	30773	1709	108.0	30106	1672
26	39	1.00	1.75	131.0	36754	1884	105.0	35289	1809
	42			134.0	43325	2063	102.0	40594	1933
	36			141.5	37972	1998	120.5	37272	1961
	40			143.6	42545	2127	118.4	41335	2066
28	42	1.05	1.80	145.7	47405	2257	116.3	45484	2165
	45			146.8	55242	2455	113.2	51802	2302
	40			160.0	47666	2383	138.0	46932	2346
	42			162.2	53108	2528	135.8	51840	2468
30	45	1.10	1.90	165.5	61880	2750	132.5	59405	2640
	48			168.8	71397	2974	129.2	67120	2796
	42			172.5	56340	2682	149.5	55573	2646
	46			177.1	68931	2997	144.9	66827	2905
32	48	1.15	2.05	179.4	75756	3156	142.6	72515	3025
	52			184.0	90486	3480	138.0	84352	3244
	45			184.2	68365	3038	157.8	67300	2991
	50			190.2	86413	3458	151.8	83136	3325
34	51	1.20	2.15	181.4	90305	3541	150.6	86374	3387
	55			198.2	106838	3885	145.8	99429	3615
	46			193.5	74619	3244	168.5	73785	3208
	50			198.5	89864	3594	163.5	87577	3503
36	54	1.25	2.25	203.5	106698	3951	158.5	101838	3771
	58			208.5	125159	4315	153.5	116276	4009
	55			218.2	17797	4283	177.8	114759	4173
	58			222.3	132693	4575	173.7	127444	4394
40	60	1.35	2.40	225.0	143179	4772	171.0	135979	4532
	65			231.7	171375	5273	144.3	157312	4840

www.PECCADAN.com

+98-216649944

حماله لانه زنبوری

برش پای نر $H = c = 1/5 h$
 $h = \frac{1h}{4}$

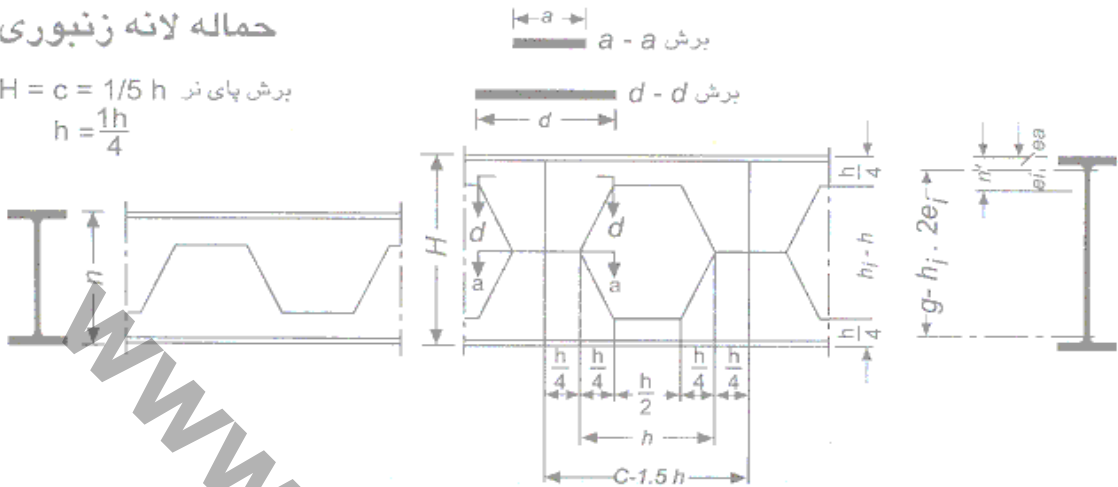

حماله غلطک خورده	h	H	e _a	e _i	g	F _g	J _{xg}	W _{xl}	W _{xa}	S _{xg}	F _a	J _a	W _a	F _d	J _d	W _d
	mm	mm	mm	mm	mm	cm ⁵	cm ⁴	cm ³	cm ³	cm ³	cm ²	cm ⁴	cm ³	cm ²	cm ⁴	cm ³
حماله لانه زنبوری از تیر آهن نیم عریض IPE IPE o IPE v																
IPE 180	180	270	8.8	35.2	252	9.6	10.5	2.9	11.9	3.5	4.8	32.2	7.2	9.5	258	28.6
IPE 180	182	273	8.3	36.2	254	10.9	12	3.3	12.6	4	5.5	37.7	8.3	10.9	301	33.1
IPE 200	200	300	9.7	40.3	281	14.4	16.3	3.8	15.6	4.7	6.6	46.7	9.3	11.4	373	41.3
IPE 200	202	303	10.1	40.4	283	12.9	17.2	4.3	17	5.2	6.3	53.2	10.5	12.5	420	42.2
IPE 220	220	330	10.6	44.5	308	18.4	20.6	4.9	20.1	6	6.5	65.4	11.9	13	528	47.6
IPE 220	222	333	10.9	44.6	311	15	24.4	5.5	22.3	6.7	7.3	75.2	13.6	14.7	602	54.2
IPE 240	240	360	11.3	48.7	337	19.8	29.7	6.1	26.4	7.6	7.4	89.3	14.9	14.9	714	59.5
IPE 240	242	363	11.9	48.6	339	17.6	33.7	6.9	28.5	8.5	8.5	103	17.1	16.9	827	68.3
IPE 270	270	405	12.4	55.1	380	28.5	45.4	8.2	36.5	10.2	9.9	135	21	17.4	1080	80.2
IPE 270	274	411	13.2	55.3	385	24.5	42.5	9.6	40.2	11.8	10.3	161	21.5	20.5	1290	93.8
IPE 300	300	450	13.7	61.3	423	31.6	61.3	11	49.2	13.9	10.6	200	25.6	21.3	1600	106
IPE 300	304	456	14.3	61.7	427	26.3	77.5	12.6	64.2	16.4	12.2	234	30.5	24.3	1870	123
IPE 330	330	495	15	67.5	464	25.1	94.8	14.1	63.1	17.3	12.4	281	34	24.8	2250	136
IPE 330	334	501	15.8	67.7	469	29.2	109	16.1	69.4	19.8	14.2	330	39.5	26.4	2640	158
IPE 360	360	540	16.4	73.6	507	29.2	131	17.6	80.1	21.9	14.4	389	43.2	28.8	3110	173
IPE 360	364	546	17.3	73.7	511	33.7	152	20.7	86.2	25.3	16.7	462	50.8	33.5	3700	203
IPE 400	400	600	18.5	81.5	563	33.6	193	23.6	104	28.9	17.2	573	57.3	34.4	4590	229
IPE 400	404	606	19.3	81.7	567	38.4	220	26.9	114	32.8	19.6	666	65	39.2	5330	264
IPE 400	408	612	20	82	572	42.7	244	29.7	122	36.1	21.6	750	73.5	43.2	6000	994
IPE 450	450	675	21.2	91.3	633	38.8	297	32.6	140	38.3	21.1	892	79.3	42.8	7140	317
IPE 450	456	680	22.4	91.6	639	46.3	353	38.6	158	46.4	25.1	1090	95.3	50.2	8690	381
IPE 450	460	690	23.5	91.5	643	51.7	400	43.8	171	52.3	26.7	1260	109	57	10060	437
IPE 500	500	750	24	101	702	45	440	43.5	183	52.2	28.5	1330	108	57	10620	425
IPE 500	506	759	25.3	101	708	53.2	522	51.8	206	61.6	30.4	1620	128	60.7	12950	512
IPE 500	514	771	27.1	101	717	63.8	629	62	232	73.4	36.5	2010	156	73	16070	625
IPE 550	550	825	26.9	111	771	51.9	632	57.1	234	68	30.5	1920	140	61	15390	650
IPE 550	556	834	28.1	111	778	60.4	732	66	260	78.3	35.3	2270	164	70.6	18190	654
IPE 550	566	849	31.5	110	785	76.8	983	89.3	312	104	48.4	3230	228	96.8	25840	913
IPE 600	600	900	29.8	120	840	60	881	73.3	298	88.8	36	2700	180	72	21600	720
IPE 600	610	915	32	120	851	75.5	1120	92.7	349	109	45.8	3550	233	91.5	26370	930
IPE 600	618	927	34.3	120	858	89.1	1350	112	393	130	55.6	4420	286	111	35400	1150

مقادیر تابلو برای محاسبات ساده شده استاتیکی بکار می روند. انواع دیگر برش ممکن است .
برای محاسبه سطح مقطع لازم باید به طور خاص بدست آیند. برای بدست آوردن حماله لانه
زنبوری تیر آهن غلطک خورده (به صفحه ۵ تا ۸ مراجعه شود) را به طور دندانه ای از دیواره
میبرند. قطعات بریده شده را بصورت حماله ای با ارتفاع بیشتر بهم جوش میدهند . در این
ضمن ممکن است ورقه هائی با ارتفاع مختلف بصورت لائی بین آنها اضافه کنند. حماله های
لانه زنبوری را ممکن است بصورت قوسی یا خم شده به شکل زین و یا بصورت حماله دوزنقه ای
ارسال داشت .



CAST IPE

یا

CAST IPA

تیر آهن ایرانی لانه زنبوری شده

IPA	H	S	t	F	a-a			b-b		
					I_x	W_x	F	I_x	W_x	
	cm	cm	cm	cm ²	cm ⁴	cm ³	cm ²	cm ⁴	cm ³	
14	20			19.2	1227	122	13.6	1159	115	
	21	0.47	0.69	15.7	1374	130	13.1	1266	120	
	22			20.2	1530	139	12.6	1369	124	
16	22			23.1	1801	163	17.1	1729	157	
	23			23.6	1936	173	16.6	1881	163	
	24	0.50	0.74	24.1	2202	183	16.1	2031	169	
18	25			24.6	2429	193	15.6	2177	174	
	26			27.6	2792	223	20.2	2679	213	
	27	0.53	0.80	28.1	3058	235	19.7	2975	221	
20	28			28.7	3333	246	19.1	3075	227	
	28			29.2	3625	458	18.6	3271	233	
	26			31.9	3526	271	25.1	3445	265	
22	28			33.0	4179	296	24.0	3987	284	
	30	0.56	0.85	34.1	4899	326	22.9	4525	301	
	32			35.2	5686	355	21.8	5040	315	
24	30			38.1	5617	374	28.7	5415	361	
	32			39.3	6514	407	27.5	6120	382	
	33	0.59	0.92	39.9	6991	423	26.9	6468	392	
27	35			41.1	6007	457	25.7	7142	408	
	32			44.1	7470	466	34.1	7258	453	
	34			45.3	8579	504	32.9	8165	480	
30	36	0.62	0.98	46.5	9778	543	31.7	9063	503	
	38			47.8	11071	582	30.4	9936	522	
	34			50.5	9759	574	41.3	9608	565	
33	37			52.5	11832	639	39.3	11392	615	
	40.5	0.66	1.02	54.8	14550	718	37.0	13467	665	
	43			56.5	16696	776	35.3	14893	692	
36	40			60.9	16044	802	45.7	15570	778	
	42			52.3	17934	854	45.3	17116	815	
	45	0.71	1.07	84.5	21005	933	43.2	19407	862	
38			66.6	24366	1015	41.0	21605	900		

www.PORADAN.com

+98-2166629944

www.PORADAN.com

پروفیل های تو خالی

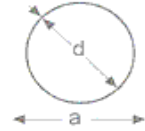
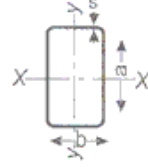
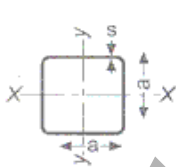

a	s	F	G	J	W	I	a	s	F	G	J	W	I	a	s	F	G	J	W	I
mm	mm	cm ²	kg/m	cm ⁴	cm ³	cm	mm	mm	cm ²	kg/m	cm ⁴	cm ³	cm	mm	mm	cm ²	kg/m	cm ⁴	cm ³	cm
پروفیل های تو خالی چهار گوش (گرم ساخته شده) طبق دین ۵۹۴۱۰ انتشار مه ۱۹۷۴																				
40	2.9	4.23	3.32	9.66	4.83	1.51	100	5	18.8	14.7	281	56.3	3.87	220	6.3	52.8	41.5	3980	362	8.68
	4	5.62	4.41	12.1	6.05	1.47		6.3	23.3	18.3	339	67.8	3.82		8	66.2	52.0	4890	445	8.60
50	2.9	5.39	4.23	19.8	7.94	1.92	120	4.5	20.5	16.1	452	75.3	4.70	260	7.1	70.5	55.4	7450	573	10.3
	4	7.22	5.67	25.4	10.1	1.87		5.6	25.1	19.7	544	90.6	4.65		8.8	86.4	67.8	8980	691	10.2
60	2.9	6.55	5.14	35.5	11.8	2.33	140	6.3	28.0	22.0	598	99.7	4.62	280	8	85.4	67.0	10430	833	10.1
	4	8.82	6.93	45.9	15.3	2.82		5.6	29.6	23.3	885	126	5.47		11	106	83.6	12650	1090	11.0
	5	10.8	8.47	54.1	18.0	2.24		7.1	37.0	29.0	1080	154	5.40		8	105	82.8	12650	903	11.0
70	3.2	8.46	6.64	62.7	17.9	2.72	160	8.8	45.0	35.3	1280	182	5.33	320	12.5	130	102	15220	1200	12.6
	4	10.4	8.18	75.3	21.5	2.69		6.3	37.7	29.6	1460	183	6.23		10	121	95.3	19240	1200	12.6
	5	12.8	10.0	89.6	25.8	2.65		8	47.0	36.9	1780	222	6.15		12.5	150	118	23270	1450	12.5
80	3.6	10.9	8.55	106	26.4	3.11	180	10	57.4	45.1	2100	263	6.05	360	16	188	148	28430	1780	12.3
	4.5	13.4	10.5	127	31.7	3.08		6.3	42.8	33.6	2120	236	7.05		16	188	148	28430	1780	12.3
	5.6	16.4	12.9	151	37.6	3.03		8	53.4	41.9	2590	288	6.97		12.5	170	133	33740	1870	14.1
90	3.6	12.3	9.68	153	34.0	3.52	200	10	65.4	51.4	3090	343	6.87	400	16	214	168	41450	2300	13.9
	4.5	15.2	11.9	185	41.0	3.48		6.3	47.8	37.5	2960	296	7.86		16	214	168	41450	2300	13.9
	5.6	18.6	14.6	220	49.0	3.44		8	59.8	46.9	3620	362	7.78		12.5	190	149	46970	2350	15.7
100	4	15.2	12.0	253	46.6	3.91	10	75.4	57.6	4340	434	7.69		16	239	188	57950	2900	15.6	
														20	294	231	69400	3470	15.4	

axb	s	F	G	J _x	W _x	I _x	d _y	W _y	I _y	axb	s	F	G	J _x	W _x	I _x	J _y	W _y	I _y
mm	mm	cm ²	kg/m	cm ⁴	cm ³	cm	cm ²	cm	cm	mm	mm	cm ²	kg/m	cm ⁴	cm ³	cm	cm ⁴	cm ³	cm
پروفیل های تو خالی مستطیل (گرم ساخته شده) طبق دین ۵۹۴۱۰ انتشار مه ۱۹۷۴																			
50 x 30	2.9	4.23	3.32	13.4	5.36	1.78	5.88	3.92	1.18	200x120	6.3	37.7	29.6	2010	201	7.30	910	152	4.91
	4	5.62	4.41	16.9	6.75	1.73	7.25	4.83	1.14		8	47.0	36.9	2440	244	7.21	1100	183	4.84
60 x 40	2.9	5.39	4.23	26.0	8.67	2.20	13.7	6.83	1.59	10	57.4	45.1	2890	289	7.10	1290	216	4.75	
	4	7.22	5.67	33.3	11.1	2.15	17.3	8.65	1.55	220x120	6.3	40.2	31.6	2540	231	7.95	992	165	4.97
70 x 40	2.9	5.97	4.69	38.1	10.9	2.53	15.7	7.83	1.62		8	50.2	39.4	3100	281	7.85	1200	200	4.89
	4	8.02	6.30	49.2	14.1	2.48	19.9	9.95	1.58	10	61.4	48.2	3680	335	7.74	1410	236	4.80	
80 x 40	2.9	6.55	5.14	53.1	13.3	2.58	17.7	8.83	1.64	260x140	6.3	47.8	37.5	4260	328	9.44	1630	233	5.85
	4	8.82	6.93	69.0	17.3	2.80	22.5	11.3	1.60		8	59.8	46.9	5220	402	9.35	1990	284	5.77
	5	10.8	8.47	81.7	20.4	2.75	26.2	13.1	1.56	10	73.4	57.6	6260	481	9.23	2370	339	5.68	
90 x 50	3.2	8.46	6.64	89.7	19.9	3.26	35.5	14.2	2.05	260x180	6.3	52.8	41.5	5070	390	9.89	2880	320	7.39
	4	10.4	8.18	108	24.0	3.22	42.3	16.9	2.02		8	66.2	52.0	6240	480	9.71	3540	393	7.31
	5	12.8	10.0	129	28.7	3.18	49.9	19.9	1.98	10	81.4	63.9	7510	578	9.60	4240	472	7.22	
100 x 50	3.6	10.2	7.98	129	25.8	3.56	42.9	17.2	2.05	280x180	7.1	62.0	48.7	6730	461	10.4	3410	379	7.42
	4.5	12.5	9.83	155	31.0	3.52	50.9	20.4	2.02		8.8	75.9	59.6	8100	578	10.3	4090	454	7.34
	5.6	15.3	12.0	184	36.8	3.47	59.4	23.8	1.97		11	93.2	73.2	9720	695	10.2	4890	543	7.24
100 x 60	3.6	10.9	8.55	146	29.1	3.66	65.2	21.7	2.45	280x220	8	75.8	59.5	8650	618	10.7	5970	543	8.88
	4.5	13.4	10.5	178	35.1	3.62	77.9	26.0	2.41		10	93.4	73.3	10460	747	10.6	7210	656	8.79
	5.6	16.4	12.9	209	41.8	3.57	91.8	30.6	2.37		12.5	115	90.1	12540	896	10.5	8620	784	8.67
120 x 60	4	13.5	10.6	247	41.1	4.27	82.7	27.6	2.47	320x180	8.8	82.9	65.1	11230	702	11.6	4600	511	7.45
	5	16.6	13.0	296	49.3	4.22	98.2	32.7	2.43		10	93.4	73.3	12510	782	11.6	5110	568	7.40
	6.3	20.5	16.1	354	59.0	4.16	116	38.6	2.38		12.5	115	90.0	14990	937	11.4	6090	677	7.29
140 x 80	4	16.7	13.1	438	62.5	5.12	183	45.7	3.31	320x220	8.8	89.9	70.6	12930	808	12.0	7270	661	8.99
	5	20.6	16.2	529	75.6	5.07	220	55.0	3.27		10	101	79.6	14430	902	11.9	8090	736	8.93
	6.3	25.5	20.0	639	91.3	5.01	263	65.8	3.21		12.5	125	97.9	17360	1080	11.8	9700	882	8.82
160 x 90	4.5	21.2	16.6	715	89.4	5.81	193	65.1	3.72	360x220	10	109	85.9	19210	1070	13.3	8980	816	9.06
	5.6	25.9	20.4	858	107	5.75	350	77.7	3.67		12.5	135	106	23170	1290	13.1	10780	980	8.94
	7.1	32.2	25.3	1030	129	5.67	418	92.9	3.60		16	169	132	28190	1570	12.9	13030	1180	8.79
180 x 100	5.6	29.3	23.0	1240	137	6.50	496	99.1	4.11	400x260	11	137	108	30330	1520	14.9	15610	1200	10.7
	7.1	36.4	28.6	1500	167	6.41	597	119	4.05		14.2	174	137	37610	1880	14.7	19280	1480	10.5
	8.8	44.2	34.7	1760	196	6.32	696	139	3.97		17.5	211	166	44440	2220	14.5	22680	1740	10.4

(* قابلیت ارسال باید از سازنده ستوال شود .

دین ۵۹۴۱۱ (طرح مه ۱۹۷۴) محتوی پروفیل تو خالی چهار گوش - مستطیل سرد ساخته شده است .

تیر آهن باریک I

ردیف-I

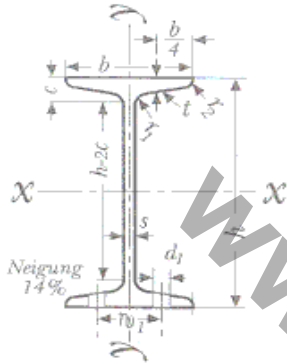

طول استاندارد

در پروفیل هائی به ارتفاع کمتر از ۳۰۰ میلی متر ۸ تا ۱۶ متر
از ۳۰۰ میلی متر به بالا ۸ تا ۱۶ متر

a_1 = فاصله بین دو مرکز دو تیر آهن برای اینکه هر دو
گشتاور ماند اصلی مساوی هم و معادل $2/x$ شوند.

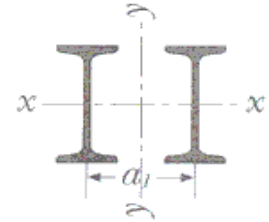

علامت اختصاری	اندازه میلی متر							F cm ²	G kg/m	برای محور خمش						سورخ های لبه طبق دین ۹۹۷ انتشار اکتبر ۱۹۷۰			
	برای									X-X			y-y			d1 mm	W1 mm	W2 mm	W3 mm
	h	b	s	t	r	c	h-2c			Jx cm ⁴	Wx cm ³	Ix cm	Jy cm ⁴	Wy cm ³	Iy cm				

تیر آهن باریک با لبه شیب دار از طرف داخل
ردیف I (گرم غلطک خورده) طبق دین ۱۰۲۵ بر گانه انتشار اکتبر ۱۹۶۳

80	80	42	3.9	5.9	2.3	10.5	59	7.57	5.94	77.8	19.5	3.20	6.29	3.00	0.91	62	6.4	22
100	100	50	4.5	6.8	2.7	12.5	75	10.6	8.34	171	34.2	4.01	12.2	4.88	1.07	78	6.4	28
120	120	58	5.1	7.7	3.1	14	92	14.2	11.1	328	54.7	4.81	21.5	7.41	1.23	94	8.4	32
140	140	66	5.7	8.8	3.4	15.5	109	18.2	14.3	573	81.9	5.61	35.2	10.7	1.40	108	11	24
160	160	74	6.3	9.5	3.8	17.5	125	22.8	17.9	935	117	6.40	54.7	14.8	1.55	124	11	40
180	180	82	6.9	10.4	4.1	19	142	27.9	21.9	1450	161	7.20	81.3	19.8	1.71	140	13 ⁹⁰	44
200	200	90	7.5	11.3	4.5	20.5	159	33.4	26.2	2140	214	8.00	117	26.0	1.87	156	13	48
220	220	98	8.1	12.2	4.9	22	176	39.5	31.1	3060	278	8.80	162	33.1	2.02	172	13	52
240	240	106	8.7	13.1	5.2	24	192	46.1	36.2	4250	354	9.59	221	41.7	2.20	188	17 13	56
260	260	113	9.4	14.1	5.6	26	208	53.3	41.9	5740	442	10.4	288	51.0	2.32	202	17	60
280	280	119	10.1	15.2	6.1	27.5	225	61.0	47.9	7590	542	11.1	364	61.2	2.45	218	17	60
300	300	125	10.8	16.2	6.5	29.5	241	69.0	54.2	9800	653	11.9	451	72.2	2.56	234	21 17	64
320	320	131	11.5	17.3	6.9	31	258	77.7	61.0	12510	782	12.7	555	84.7	2.67	248	21 17	70
340	340	137	12.2	18.3	7.3	33	274	86.7	68.0	15700	923	13.5	674	98.4	2.80	264	21	74
360	360	143	13.0	19.5	7.8	35	290	97.0	76.1	19610	1090	14.2	818	114	2.90	278	23 21	76
380	380	149	13.7	20.5	8.2	37	306	107	84.0	24010	1260	15.0	975	131	3.02	294	23 21	82
400	400	155	14.4	21.6	8.6	39.5	323	118	92.4	29210	1460	15.7	1160	149	3.13	308	23	86
425	425	163	15.3	23.0	9.2	41	343	132	104	36970	1740	16.7	1440	176	3.30	328	25 23	88
450	450	170	16.2	24.3	9.7	43.5	363	147	115	45960	2040	17.7	1730	203	3.43	348	25 23	94
475	475	176	17.1	25.5	10.3	45.5	384	163	128	56480	2390	18.6	2090	235	3.60	366	28 25	96 100
500	500	185	18.0	27.0	10.8	48	404	179	141	66740	2750	19.6	2480	268	3.72	384	100	100
550	550	200	19.0	30.0	11.9	52.5	445	212	166	99180	3610	21.6	3490	349	4.02	424	110	110
600	600	215	21.6	32.4	13.0	57.5	485	264	199	139000	4630	23.1	4670	434	4.30	460	120	120

I ۵۵۰ و ۶۰۰ در کارخانه های غلطک زنی آلمان فقط در صورت در خواست مخصوص تهیه می شود .

(* چنانچه برای d1 و W1 اندازه های بیشتری داده باشند ، باید توضیح مربوط صفحه ۲ رعایت گردد .

(* پیچ های استاندارد شده برای اتصال های HV در اینجا قابل مصرف نیستند .

D	S	F	G	J	W	I	D	s	F	G	J	W	I
mm	mm	cm ²	kg/m	cm ⁴	cm ³	cm	mm	mm	cm ²	kg/m	cm ⁴	cm ³	cm
پروفیل تو خالی گرد انتخاب } لوله فولادی بدون درز طبق دین ۲۴۴۸ انتشار روش ۱۹۶۶ } لوله فولادی جوش خورده طبق دین ۲۴۵۸													
21.3	2	1.21	0.962	0.571	0.536	0.686	193.7	4.5 ²⁾	26.7	21.0	1200	124	6.69
	2.6	1.53	1.21	0.681	0.639	0.668		5 ²⁾	29.6	23.3	1320	136	6.67
	3.2	1.82	1.44	0.768	0.722	0.650		5.4 ¹⁾	31.9	25.0	1420	146	6.66
26.9	2 ²⁾	1.56	1.24	1.22	0.907	0.883		6.3	37.1	29.1	1630	168	6.63
	2.6	1.98	1.57	1.48	1.10	0.864		7.1	41.6	32.8	1810	187	6.60
	3.2	2.38	1.89	1.70	1.27	0.846		8	46.7	36.5	2020	208	6.57
33.7	2.6	2.54	2.01	3.09	1.84	1.10		8.8	51.1	40.0	2190	226	6.54
	3.2	3.07	2.42	3.60	2.14	1.08	219.1	4.5 ²⁾	30.3	23.8	1750	159	7.59
	4	3.73	2.95	4.19	2.49	1.06		5 ²⁾	33.6	26.4	1930	176	7.57
42.4	2.6	3.25	2.57	6.46	3.05	1.41		5.9 ¹⁾	39.5	31.0	2250	205	7.54
	3.2	3.94	3.11	7.62	3.59	1.39		6.3	42.1	33.1	2390	218	7.53
	4	4.83	3.81	8.99	4.24	1.36		7.1	47.3	37.2	2660	243	7.50
48.3	2.6	3.73	2.95	9.78	4.05	1.62		8.8	58.1	45.4	3220	294	7.44
	3.2	4.53	3.59	11.6	4.80	1.60		10	65.7	51.6	3600	328	7.40
	4	5.57	4.41	13.8	5.70	1.57	244.5	6.3	47.1	37.1	3350	274	8.42
60.3	2.9	5.23	4.14	21.6	7.16	2.03		8	59.4	46.5	4160	340	8.37
	3.6	6.41	5.07	25.9	8.58	2.01		10	73.3	57.8	5070	415	8.30
	4	7.07	5.59	28.2	9.34	2.00		11	80.7	63.6	5510	451	8.26
	5	8.69	6.82	33.5	11.1	1.96	273.0	5 ²⁾	42.1	33.1	3780	277	9.48
76.1	2.9	6.67	5.82	44.7	11.8	2.59		5.6 ²⁾	47.0	36.9	4210	308	9.46
	3.6	8.20	6.49	54.0	14.2	2.57		6.3	52.8	41.4	4700	344	9.43
	4	9.06	7.17	59.1	15.5	2.55		7.1	59.3	46.7	5240	384	9.40
	5	11.2	8.77	70.9	18.6	2.52		8.8	73.0	57.1	6880	467	9.37
88.9	3.2	8.62	6.81	79.2	17.3	3.03		11	90.5	71.4	7780	570	9.27
	3.6	9.65	7.57	87.4	19.8	3.02	323.9	5 ²⁾	50.1	39.3	6370	393	11.8
	4	10.7	8.43	96.3	21.7	3.00		5.6 ²⁾	56.0	44.0	7090	438	11.3
	5	13.2	10.3	116	26.2	2.97		6.3 ²⁾	62.9	49.3	7930	490	11.2
	6.3 ¹⁾	16.3	12.9	140	31.5	2.93		7.1	70.7	55.6	8870	548	11.2
101.6	3.6	11.1	8.76	133	26.2	3.47		8.8	87.1	68.1	10820	668	11.1
	4.5	13.7	10.7	162	31.9	3.44		11	108	85.3	13250	818	11.1
	5.6	16.9	13.2	195	38.4	3.40	355.6	8	87.4	68.3	13200	742	12.3
	7.1	21.1	16.8	237	46.6	3.35		10	109	85.2	16220	912	12.2
108.0	3.6	11.8	9.27	161	29.8	3.69		12.5	135	107	19850	1120	12.1
	4.5	14.6	11.5	196	36.4	3.66	406.4	8.8	110	85.9	21730	1070	14.1
	5.6	18.0	14.1	237	43.9	3.63		11	137	108	26720	1320	14.0
114.3	3.6	12.5	9.90	192	33.6	3.92		14.2 ¹⁾	175	138	33890	1660	13.9
	4.5	15.5	12.1	234	41.0	3.89	457.2	10	140	110	35140	1540	15.8
	5.8	19.1	15.0	283	49.6	3.85		14.2 ¹⁾	198	156	48350	2120	15.7
	2.1	23.9	18.8	345	60.4	3.80		17.5 ¹⁾	282	189	58510	2560	15.6
133.0	4	16.2	12.7	337	50.8	4.56	508.0	8.8 ²⁾	138	108	43000	1690	17.7
	5.6	22.4	17.6	456	68.5	4.51		20 ¹⁾	307	241	91430	3660	17.3
	6.3	25.1	19.7	504	75.9	4.49	558.8	8.8 ²⁾	152	119	57510	2060	19.4
139.7	4	17.1	13.5	393	56.2	4.80		20 ¹⁾	330	266	123000	4400	19.1
	5.8	23.6	18.5	531	76.1	4.75	609.6	10 ²⁾	188	148	84680	2780	21.2
	8.3	26.4	20.8	589	84.3	4.72	711.2	10 ²⁾	220	173	135400	3810	24.5
	7.1	29.6	23.3	652	93.3	4.69	812.8	16 ²⁾	401	313	318000	7820	28.2
159.0	4.5	21.8	17.2	652	82.1	5.46	914.4	10 ²⁾	284	223	290500	6350	32.0
	5.6	27.0	21.2	795	100	5.43		25 ²⁾	699	552	691200	15120	31.5
	6.3	30.2	23.7	882	111	5.40	1016.0	10 ²⁾	316	248	399800	7870	35.6
168.3	4.5	23.2	18.1	777	92.4	5.79		25 ²⁾	778	615	956100	18820	35.0
	5.6	28.6	22.4	948	113	5.76							
	6.3	32.1	25.2	1050	125	5.73							
	7.1	36.0	28.3	1170	139	5.70							
	8.8 ¹⁾	44.1	34.5	1410	167	5.65							

پروفیل تو خالی کرد این تابلو هم بصورت بدون درز و هم جوش داده تهیه می شوند. استثنا آنهاست هستند که در زیر با علامت ۱) فقط بدون درز ۲) جوشکاری شده می باشند.

پروفیل تو خالی گرد سنگین طبق قانون انتشار ژوئیه ۱۹۷۲ نیم سنگین طبق دین ۲۴۴۰ انتشار ژوئیه ۱۹۷۲

10.2	2.0	0.515	0.407	0.046	0.090	0.298	10.2	2.65	0.628	0.493	0.050	0.099	0.283
13.5	2.35	0.823	0.650	0.134	0.198	0.403	13.5	2.9	0.966	0.769	0.146	0.216	0.388
17.2	2.35	1.10	0.852	0.310	0.360	0.532	17.2	2.9	1.30	1.02	0.347	0.403	0.516
21.3	2.65	1.55	1.22	0.689	0.647	0.666	21.3	3.25	1.84	1.45	0.775	0.728	0.648
26.9	2.65	2.02	1.58	1.50	1.12	0.863	26.9	3.25	2.41	1.90	1.72	1.28	0.844
33.7	3.25	3.11	2.44	3.64	2.16	1.08	33.7	4.05	3.77	2.97	4.22	2.51	1.06
42.4	3.25	4.00	3.14	7.71	3.64	1.38	42.4	4.05	4.88	3.84	9.07	4.28	1.36
48.3	3.25	4.60	3.61	11.7	4.86	1.60	48.3	4.05	5.63	4.43	13.9	5.75	1.57
60.3	3.65	6.50	5.10	26.2	8.68	2.01	60.3	4.5	7.89	6.17	30.9	10.2	1.98
76.1	3.65	8.31	6.51	54.6	14.4	2.56	76.1	4.5	10.1	7.90	65.1	17.1	2.54
88.9	4.05	10.8	8.47	97.4	21.9	3.00	88.9	4.85	12.8	10.1	113	25.5	2.98
114.3	4.5	15.5	12.1	234	41.0	3.89	114.3	5.4	18.5	14.4	275	48.0	3.86
139.7	4.85	20.5	16.2	468	66.9	4.77	139.7	5.4	22.8	17.8	514	73.7	4.75
165.1	4.85	24.4	19.2	784	95.0	5.67	165.1	5.4	27.1	21.2	865	105	5.65

* نوع ارسال معمول بدون پیچ و موف و طول معمول تهیه شده ۶ متر است

آهن نبشی دو طرف مساوی

طول استاندارد ۶ تا ۱۲ متر

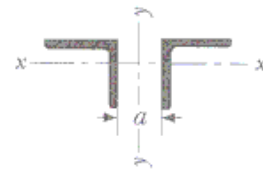
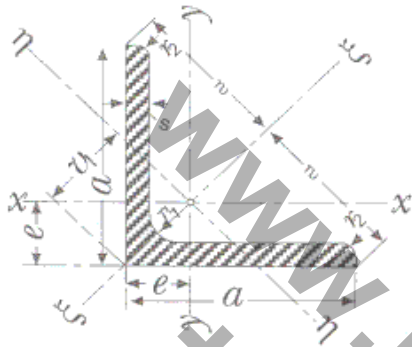

برای هر فاصله C₁ گشتاور ماند اصلی نسبت به محور y-y بزرگتر از گشتاور اصلی نسبت به محور x-x میشود.

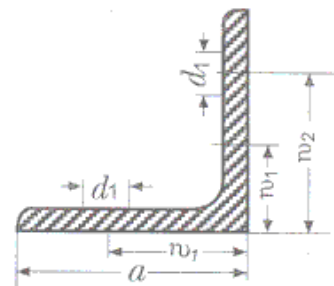

اندازه بملیمتر		F		G		فاصله محورها											سوراخ های لبه	
a	s	r1	r2			x-y = x-y		ξ-ξ		η-η				d1	w1			
علامت اختصاری				e	w	v1	Jx=Jy	Wx=Wy	Ix=Iy	J	Iξ	Iη	Wη	Iη				
				cm	cm	cm	cm ⁴	cm ³	cm	cm ⁴	cm	cm ⁴	cm ³	cm	mm			
نبشی دو طرف مساوی گوشه گرد (گرم فلک خورده) طبق دین ۱۰۲۸ انتشار اکتبر ۱۹۶۳																		
نرم اروپایی ۶۵-۵۶ قسمتی از این ۱۰۲۸ منحرف میشود.																		
20 x 3	4	3,5	2	1,12	0,88	0,60	1,41	0,85	0,39	0,28	0,59	0,62	0,74	0,15	0,18	0,37		
				1,45	1,14	0,64	1,41	0,90	0,48	0,35	2,88	0,77	0,73	0,19	0,21	0,36		
25 x 3	4	3,5	2	1,42	1,12	0,73	1,77	1,03	0,79	0,45	0,75	1,27	0,95	0,31	0,30	0,47		
				1,85	1,45	0,76	1,77	1,08	1,01	0,58	0,74	1,61	0,93	0,40	0,37	0,47		
	5			2,26	1,77	0,80		1,13	1,18	0,89	0,72	1,87	0,91	0,50	0,44	0,47		
30 x 3	4	5	2,5	1,74	1,36	0,84	2,12	1,18	1,41	0,85	0,90	2,24	1,14	0,57	0,48	0,57		
				2,27	1,78	0,89		1,24	1,81	0,86	0,89	2,85	1,12	0,78	0,61	0,58		
	5			2,78	2,18	0,92		1,30	2,16	1,04	0,88	3,41	1,11	0,91	0,70	0,57		
35 x 3	4	5	2,5	2,04	1,60	0,96	2,47	1,36	2,29	0,90	1,06	3,63	1,34	0,95	0,70	0,68		
				2,67	2,10	1,00		1,41	2,96	1,18	1,05	4,88	1,33	1,24	0,86	0,68		
	5			2,28	2,57	1,04		1,47	3,56	1,45	1,04	5,63	1,31	1,49	1,01	0,67		
	6			3,87	3,04	1,08		1,53	4,14	1,71	1,04	6,50	1,30	1,77	1,16	0,68		
40 x 3	4	6	3	2,35	1,84	1,07	2,83	1,52	3,45	1,18	1,21	5,45	1,52	1,44	0,95	0,78		
				3,08	2,42	1,12		1,58	4,48	1,56	1,21	7,09	1,52	1,86	1,18	0,78		
	5			3,79	2,97	1,16		1,64	5,43	1,91	1,20	8,64	1,51	2,22	1,35	0,77		
	6			4,48	3,52	1,20		1,70	6,33	2,26	1,19	9,98	1,49	2,67	1,57	0,77		
45 x 4	5	7	3,5	3,49	2,74	1,23	3,18	1,75	6,43	1,97	1,36	10,2	1,71	2,68	1,53	0,88		
				4,30	3,38	1,28		1,81	7,83	2,43	1,35	12,4	1,70	3,25	1,80	0,87		
	6			5,09	4,00	1,32		1,87	9,16	2,88	1,34	14,5	1,69	3,83	2,05	0,87		
	7			5,86	4,60	1,36		1,92	1,04	3,31	1,33	16,4	1,67	6,39	2,29	0,87		
50 x 4	5	7	3,5	3,89	3,06	1,36	3,54	1,92	8,97	2,46	1,52	14,2	1,91	3,73	1,94	0,98		
				4,80	3,77	1,40		1,98	11,0	3,05	1,51	17,4	1,90	4,59	2,32	0,98		
	6			5,59	4,47	1,45		2,04	12,8	3,61	1,50	20,4	1,89	5,24	2,57	0,96		
	7			6,56	5,15	1,49		2,11	14,6	4,15	1,49	23,1	1,88	6,02	2,85	0,96		
	8			7,41	5,82	1,52		2,16	16,3	4,68	1,48	25,7	1,86	6,87	3,19	0,96		
	9			8,24	6,47	1,56		2,21	17,9	5,20	1,47	28,1	1,85	7,67	3,47	0,97		
55 x 5	6	8	4	5,32	4,18	1,52	3,89	2,15	14,7	3,70	1,66	23,3	2,09	6,11	2,84	1,07		
				6,31	4,95	1,56		2,21	17,3	4,40	1,66	27,4	2,08	7,24	3,28	1,07		
	8			8,23	6,46	1,64		2,32	22,1	5,72	1,64	34,8	2,06	9,35	4,03	1,07		
	10			1,01	7,90	1,72		2,43	29,3	6,97	1,62	41,4	2,02	1,13	4,65	1,06		
60 x 5	6	8	4	5,82	4,57	1,64	4,24	2,32	19,4	4,45	1,82	30,7	2,30	8,03	3,46	1,17		
				6,91	5,42	1,69		2,39	22,8	5,29	1,82	36,1	2,29	9,43	3,95	1,17		
	8			9,03	7,09	1,77		2,50	29,1	6,88	1,80	46,1	2,26	1,21	4,84	1,16		
	10			11,1	8,69	1,85		2,62	34,9	8,41	1,78	55,1	2,23	1,46	5,57	1,15		

فواصل سوراخ ها در آهن نبشی دو طرف مساوی : طبق دین ۹۹۹ انتشار اکتبر ۱۹۷۰

(* چنانچه برای d1 یا w1 اندازه های زیادتری داده شده باشد، باید توضیح مربوطه در صفحه ۳ مراعات شود.

(** پیچ های استاندارد شده برای اتصال های HV در اینجا بکار نمیروند.

اندازه ب میلیمتر			F	G	فاصله برای محورها			برای محور خمش						سوراخ های لیه (طبق دین ۹۹۷) انتشار اکتبر ۱۹۷۰				
a	b	r1			r2	e	w	v1	x-y = x-y		ξ-ξ		η-η		d1	w1	w2	
علامت اختصاری			cm ²	kg/m	cm	cm	cm	Jx=Jy cm ⁴	Wx=Wy cm ³	ix=iy cm	Jξ cm ⁴	Jη cm ⁴	wη cm ³	iη cm	mm	mm	mm	
<p>L نیشی گوشه کرد دو طرف مساوی (گرم غلطک خورده) طبق دین ۱۰۲۸ انتشار اکتبر ۱۹۶۳</p>																		
65 x 6	7	8	9	4.5	7.53	5.91	1.80	2.55	29.2	6.21	1.97	46.3	2.48	12.1	4.76	1.27	21	35
7	8	9	11	4.5	8.70	6.83	1.85	2.62	33.4	7.18	1.98	53.0	2.47	13.8	5.27	1.26		
8	9	11	4.5	9.85	7.73	1.89	2.67	37.5	8.13	1.95	59.4	2.46	15.6	5.84	1.26			
9	11	4.5	4.5	11.0	8.62	1.93	2.73	41.3	9.04	1.94	65.4	2.44	17.2	6.30	1.25			
70 x 6	7	8	9	4.5	8.13	6.38	1.93	2.73	36.9	7.27	2.13	58.5	2.68	15.3	5.60	1.37	21	40
7	8	9	11	4.5	9.40	7.38	1.97	2.79	42.6	8.43	2.12	67.1	2.67	17.6	6.31	1.37		
8	9	11	4.5	11.9	9.34	2.05	2.90	52.6	10.6	2.10	83.1	2.64	22.0	7.59	1.36			
9	11	4.5	4.5	14.3	11.2	2.13	3.01	61.8	12.7	2.08	97.6	2.61	26.0	8.64	1.35			
75 x 6	7	8	9	5	8.75	6.87	2.04	2.89	45.6	8.35	2.28	72.2	2.87	18.9	6.54	1.47	23	40
7	8	9	10	5	10.1	7.94	2.09	2.95	52.4	9.67	2.28	83.6	2.88	21.1	7.15	1.45		
8	9	10	5	11.5	9.03	2.13	3.01	58.9	11.0	2.26	93.3	2.85	24.4	8.11	1.46			
9	10	5	5	14.1	11.1	2.21	3.12	71.4	13.5	2.25	113	2.83	29.8	9.55	1.45			
80 x 7	8	9	10	5	10.8	8.49	2.21	3.13	64.2	11.1	2.44	102	3.07	26.5	8.48	1.57	23	45
8	9	10	5	12.3	9.66	2.26	3.20	72.3	12.6	2.42	115	3.06	29.6	9.25	1.55			
9	10	5	5	15.1	11.9	2.34	3.31	87.5	15.5	2.41	139	3.03	35.9	10.9	1.54			
10	12	5	5	17.9	14.1	2.41	3.41	102	18.2	2.39	161	3.00	43.0	12.6	1.53			
80 x 7	8	9	10	5	20.6	16.1	2.48	3.51	115	20.8	2.36	181	2.96	48.6	13.9	1.54		
90 x 8	9	10	11	5.5	13.9	10.9	2.50	3.53	104	16.1	2.74	165	3.45	43.5	12.3	1.77	25	50
9	10	11	5.5	15.5	12.2	2.54	3.59	116	18.0	2.74	184	3.45	47.8	13.3	1.76			
10	11	5.5	5.5	18.7	14.7	2.62	3.70	138	21.6	2.72	218	3.41	57.1	15.4	1.75			
11	13	5.5	5.5	21.8	17.1	2.70	3.81	158	25.1	2.69	250	3.39	65.9	17.3	1.74			
100 x 8	9	10	11	6	15.5	12.2	2.74	3.87	145	19.9	3.06	230	3.85	59.9	15.5	1.96	25	55
9	10	6	6	19.2	15.1	2.82	3.99	177	24.7	3.04	280	3.82	73.3	18.4	1.95			
10	11	6	6	22.7	17.8	2.90	4.10	207	29.2	3.02	328	3.80	86.2	21.0	1.95			
11	13	6	6	26.2	20.6	2.98	4.21	236	33.5	3.00	372	3.77	98.3	23.4	1.94			
100 x 8	9	10	11	6	29.6	23.2	3.06	4.32	262	37.7	2.97	413	3.74	111	25.6	1.93		
100 x 8	9	10	11	6	38.2	28.4	3.20	4.53	311	45.7	2.93	487	3.67	135	29.8	1.93		
110x10	12	13	14	6	21.2	16.6	3.07	4.34	239	30.1	3.36	379	4.23	98.6	22.7	2.16	25	45
12	13	6	6	25.1	19.7	3.15	4.45	280	35.7	3.34	444	4.21	116	26.1	2.15			
14	6	6	6	29.0	22.8	3.21	4.54	319	41.0	3.32	505	4.18	133	29.3	2.14			
110x10	12	13	14	6	4.34	239	30.1	3.36	379	4.23	98.6	22.7	2.16				45	70
12	13	6	6	4.45	280	35.7	3.34	444	4.21	116	26.1	2.15						
14	6	6	6	4.54	319	41.0	3.32	505	4.18	133	29.3	2.14						
120 x 11	12	13	14	6.5	25.4	19.9	3.36	4.75	341	39.5	3.66	541	4.62	140	29.5	2.35	25	50
12	13	6.5	6.5	27.5	21.6	3.40	4.80	368	42.7	3.65	584	4.60	152	31.6	2.35			
13	14	6.5	6.5	29.7	23.3	3.44	4.86	394	46.0	3.64	625	4.59	162	33.3	2.34			
120 x 11	12	13	14	6.5	33.9	26.6	3.51	4.95	446	52.5	3.63	705	4.56	186	37.5	2.34		
130 x 12	14	14	7	7	30.0	23.6	3.64	5.15	472	50.4	3.97	750	5.00	194	37.7	2.54	25	50
14	14	7	7	34.7	27.2	3.72	5.26	540	58.2	3.94	857	4.97	223	42.4	2.53			
16	7	7	7	39.3	30.9	3.80	5.37	605	65.8	3.92	959	4.94	251	46.7	2.52			
130 x 12	14	14	7	7	5.15	472	50.4	3.97	750	5.00	194	37.7	2.54				50	90
14	14	7	7	5.26	540	58.2	3.94	857	4.97	223	42.4	2.53						
16	7	7	7	5.37	605	65.8	3.92	959	4.94	251	46.7	2.52						
140 x 13	15	15	7.5	7.5	35.0	27.5	3.92	5.54	638	63.3	4.27	1010	5.38	262	47.3	2.74	28	55
15	7.5	7.5	7.5	40.0	31.4	4.00	5.66	723	72.3	4.25	1150	5.36	298	52.7	2.73			
140 x 13	15	15	7.5	7.5	4.27	1010	63.3	4.27	1010	5.38	262	47.3	2.74				55	95
15	7.5	7.5	7.5	4.25	1150	72.3	4.25	1150	5.36	298	52.7	2.73						
150 x 12	14	15	16	8	34.8	27.3	4.12	5.83	737	67.7	4.60	1170	5.80	303	52.0	2.95	28	60
14	8	8	8	40.3	31.6	4.21	5.95	845	78.2	4.58	1340	5.77	347	58.3	2.94			
15	8	8	8	43.0	33.8	4.25	6.01	898	83.5	4.57	1430	5.76	370	61.1	2.93			
16	8	8	8	45.7	35.9	4.29	6.07	949	88.7	4.56	1510	5.74	391	64.4	2.93			
150 x 12	14	15	16	8	51.0	40.1	4.36	6.17	1050	99.3	4.54	1670	5.70	438	71.0	2.93		
150 x 12	14	15	16	8	56.3	44.2	4.44	6.28	1150	109	4.51	1820	5.68	477	76.0	2.91		
150 x 12	14	15	16	8	6.17	1050	99.3	4.54	1670	5.70	438	71.0	2.93				60	65
16	8	8	8	6.28	1150	109	4.51	1820	5.68	477	76.0	2.91						
160 x 15	17	17	8.5	8.5	46.1	36.2	4.49	6.35	1100	95.6	4.88	1750	6.15	453	71.3	3.14	28	60
17	8.5	8.5	8.5	51.8	40.7	4.57	6.46	1230	108	4.86	1950	6.13	506	78.3	3.13			
19	8.5	8.5	8.5	57.5	45.1	4.05	6.58	1350	118	4.84	2140	6.10	558	84.8	3.12			
160 x 15	17	17	8.5	8.5	4.88	1750	95.6	4.88	1750	6.15	453	71.3	3.14				60	115
17	8.5	8.5	8.5	4.86	1950	108	4.86	1950	6.13	506	78.3	3.13						
19	8.5	8.5	8.5	4.84	2140	118	4.84	2140	6.10	558	84.8	3.12						
180 x 16	18	18	9	9	55.4	43.5	5.02	7.11	1680	130	5.51	2690	6.96	679	95.5	3.50	28	60
18	9	9	9	61.9	48.6	5.10	7.22	1870	145	5.49	2970	6.93	757	105	3.49			
20	9	9	9	68.4	53.7	5.18	7.33	2040	160	5.47	3260	6.90	830	113	3.49			
22	9	9	9	74.7	58.6	5.26	7.44	2210	174	5.44	3510	6.86	918	123	3.50			
180 x 16	18	18	9	9	7.11	1680	130	5.51	2690	6.96	679	95.5	3.50				60	135
18	9	9	9	7.22	1870	145	5.49	2970	6.93	757	105	3.49						
20	9	9	9	7.33	2040	160	5.47	3260	6.90	830	113	3.49						
22	9	9	9	7.44	2210	174	5.44	3510	6.86	918	123	3.50						
200 x 16	18	18	9	9	61.8	48.5	5.52	7.80	2340	162	6.15	3740	7.78	943	121	3.91	28	65
18	9	9	9	69.1	54.3	5.60	7.92	2600	181	6.13	4150	7.75	1050	133	3.90			
20	9	9	9	76.4	59.9	5.68	8.04	2850	199	6.11	4540	7.72	1160	144	3.89			
24	9	9	9	90.6														

آهن سپری

طول استاندارد ۶ تا ۱۲ سانتیمتر

b : h
1 : 1 b : h
2 : 1

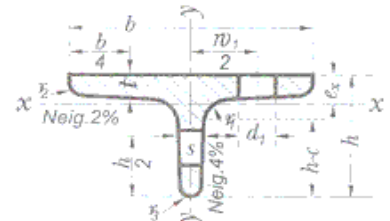
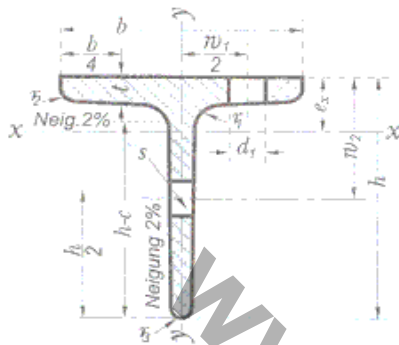

x-x فاصله محور ثقل = ex

علامت اختصاری	اندازه برای							F	G	ex	برای محور خمش						سوراخ های لبه طبق دین ۹۹۷ انتشار اکتبر ۱۹۷۰		
	h	b	s=t=r	t2	r3	e	h-c				x-x			y-y			d1	W1	W2
											Jx	Wx	Ix	Jy	Wy	Iy			
T	سپری گوشه گرد (گرم غلطک خورده) طبق دین ۱۰۲۴ انتشار اکتبر ۱۹۶۳																		
20	20	20	3	1.5	1	7	13	1.12	0.88	0.58	0.38	0.27	0.53	0.20	0.20	0.42	3.2	-	-
25	25	25	3.5	2	1	8	17	1.64	1.29	0.73	0.87	0.49	0.73	0.43	0.34	0.51	3.2	15	14
30	30	30	4	2	1	9	21	2.26	1.77	0.85	1.72	0.80	0.87	0.87	0.58	0.62	4.3	17	17
35	35	35	4.5	2.5	1	10	25	2.97	2.33	0.99	3.10	1.23	1.04	1.57	0.90	0.73	4.3	19	19
40	40	40	5	2.5	1	11	29	3.77	2.96	1.12	5.28	1.84	1.18	2.58	1.29	0.83	6.4	21	22
45	45	45	5.5	3	1.5	12	33	4.67	3.67	1.26	8.13	2.51	1.32	4.01	1.78	0.93	6.4	24	25
50	50	50	6	3	1.5	13	37	5.66	4.44	1.39	1.21	3.35	1.46	6.06	2.42	1.03	6.4	30	30
60	60	60	7	3.5	2	15	45	7.94	6.23	1.66	2.38	5.48	1.73	12.2	4.07	1.24	8.4	34	35
70	70	70	8	4	2	17	53	10.6	8.32	1.94	44.5	8.79	2.05	22.1	6.32	1.44	11	38	40
80	80	80	9	4.5	2	19	61	13.6	10.7	2.22	73.7	12.8	2.33	37.0	9.25	1.65	11	45	45
90	90	90	10	5	2.5	21	69	17.1	13.4	2.48	119	18.2	2.64	58.5	13.0	1.85	13	50	50
100	100	100	11	5.5	3	23	77	20.9	16.4	2.74	179	24.6	2.94	88.3	17.7	2.05	13	60	60
120	120	120	13	6.5	3	27	93	29.6	23.2	3.28	366	42.0	3.51	178	29.7	2.45	17	70	70
140	140	140	15	7.5	4	31	109	39.9	31.3	3.80	660	54.7	4.07	330	47.2	2.88	21	80	75

سپری گوشه گرد لبه پهن (گرم غلطک خورده) طبق دین ۱۰۲۴ انتشار اکتبر ۱۹۶۳																			
30	30	60	5.5	3	1.5	11	19	4.64	3.64	0.67	2.58	1.11	0.75	8.52	2.87	1.36	8.4	34	-
35	35	70	6	3	1.5	12	23	5.94	4.66	0.77	4.49	1.65	0.87	15.1	4.31	1.59	11	37	-
40	40	80	7	3.5	2	14	26	7.91	6.21	0.88	7.81	2.50	0.99	28.5	7.13	1.90	11	45	-
50	50	100	8.5	4.5	2	17	33	12.0	9.24	1.09	18.7	4.78	1.25	67.7	13.5	2.38	13	55	-
60	60	120	10	5	2.5	20	40	17.0	13.4	1.30	38.0	8.09	1.49	13.7	22.8	2.84	17	65	-

علامت اختصاری	h-b	s-t	F	G	Wx	Wy
	mm	mm	cm ²	kg/m	cm ³	cm
سپری گوشه تیز با لبه و پهلوهای مساوی طبق دین ۵۹۰۵۱ انتشار اکتبر ۱۹۶۳						
20	20	3	1.11	0.871	0.39	0.20
25	25	3.5	1.63	1.28	0.53	0.37
30	30	4	2.24	1.76	0.88	0.61
35	35	4.5	2.95	2.31	1.36	0.93
40	40	5	3.75	2.94	1.97	1.35

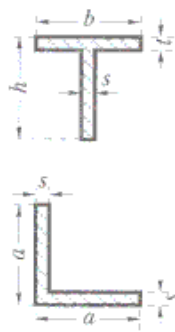

علامت اختصاری	a	s	F	G	Wx	Wy
	mm	mm	cm ²	kg/m	cm ³	cm ²
سپری گوشه تیز دو طرف مساوی طبق دین ۱۰۲۴ انتشار اکتبر ۱۹۶۳						
LS						
20x3	20	3	1.11	0.871	0.28	
4	20	4	1.44	1.13	0.37	
25x3	25	3	1.41	1.11	0.47	
4	25	4	1.84	1.44	0.60	
30x3	30	3	1.71	1.34	0.88	
4	30	4	2.24	1.76	0.88	
35x4	35	4	2.64	2.07	1.22	
40x4	40	4	3.04	2.39	1.62	
5	40	5	3.75	2.94	1.97	
45x5	45	5	4.25	3.34	2.53	
50x5	50	5	4.75	3.75	3.15	

تیر آهن ناودانی

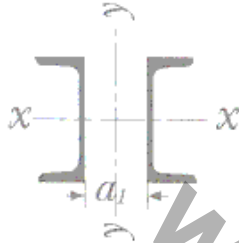

طول استاندارد
در پروفیل هایی به ارتفاع کمتر از ۳۰۰ میلیمتر از ۸ تا ۱۶ متر
از ۳۰۰ میلیمتر به بالا ۸ تا ۱۸ متر

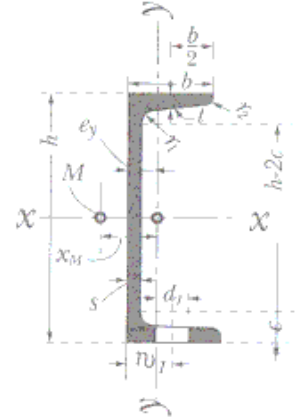

شیب داخلی لبه ها

$h \leq 300$ ۸٪ برای پروفیل های
 $h > 300$ ۵٪ برای پروفیل های

فاصله بین دوناودانی بطوری
که هر دو گشتاور ماند مساوی
هم و معادل $2/x$ شوند.

e_y = فاصله محور ثقل $y-y$
 x_{cg} = فاصله مرکز انحراف (برش یا قیچی شدن)

علامت اختصاری	اندازه بمیلیمتر برای							F		G		برای محور خمش						ey	x _M	a ₁	سوراخ های لبه طبق دین ۹۹۷ انتشار اکتبر ۱۹۷۰	
	h	b	s	t	c	h-2c	cm ²	kg/m	x-x			y-y			cm	cm	cm				d	W ₁
									I _x	W _x	i _x	I _y	W _y	i _y								
آهن باودانی گوشه گرد (گرم غلطک خورده) طبق دین ۱۰۲۶ انتشار اکتبر ۱۹۶۳																						
30x15	30	15	4	4.5	2	9	12	2.21	1.74	2.93	1.69	1.07	0.38	0.89	0.42	0.52	0.74	-	4.3	10		
30	30	33	5	7	3.5	14.5	1	5.44	4.27	6.39	4.26	1.03	0.33	2.68	0.99	1.31	2.22	-	8.4	20		
40x20	40	20	5	5.5	2.5	11	18	3.66	2.87	7.58	5.79	1.44	1.14	0.86	0.86	0.67	1.01	-	6.4	11		
40	40	35	5	7	3.5	14.5	11	6.21	4.87	14.1	7.05	1.50	6.68	3.98	1.04	1.33	2.32	-	8.4	20		
50x25	50	25	5	6	3	12.5	25	4.92	3.86	16.8	6.73	1.85	2.49	1.48	0.71	0.81	1.34	-	8.4	16		
50	50	38	5	7	3.5	15	20	7.12	5.59	26.4	10.6	1.92	9.12	3.75	1.13	1.37	2.47	4	11	20		
60	60	30	6	6	3	12.5	35	6.46	5.07	31.6	10.5	2.21	4.51	2.16	0.84	0.91	1.50	-	8.4	18		
65	65	42	5.5	7.5	4	16	33	9.03	7.09	57.5	17.7	2.52	14.1	5.07	1.25	1.42	2.60	16	11	25		
80	80	45	6	8	4	17	47	11.0	8.64	106	26.5	3.10	19.4	6.36	1.33	1.45	2.67	28	13 ^(9°)	25		
100	100	50	6	8.5	4.5	18	64	13.5	10.6	206	41.2	3.91	29.3	8.49	1.47	1.55	2.93	42	13	30		
120	120	55	7	9	4.5	19	82	17.0	13.4	364	60.7	4.62	43.2	11.1	1.59	1.60	3.03	56	17	13	30	
140	140	60	7	10	5	21	97	20.4	16.0	605	86.4	5.45	62.7	14.8	1.75	1.75	3.37	70	17	35	35	
160	160	65	7.5	10.5	5.5	22.5	116	24.0	18.8	925	116	6.21	85.3	18.3	1.89	1.84	3.56	82	21	17	35	
180	180	70	8	11	5.5	23.5	133	28.0	22.0	1350	150	6.95	114	22.4	2.02	1.92	3.75	96	21	40	40	
200	200	75	8.5	11.5	6	24.5	151	32.2	25.3	1910	191	7.70	148	27.0	2.14	2.01	3.94	108	23	21	40	
220	220	80	9	12.5	6.5	26.5	166	37.4	29.4	2690	245	8.48	197	33.6	2.30	2.14	4.20	122	23	45	45	
240	240	85	9.5	13	6.5	28	185	42.3	33.2	3600	300	9.22	248	39.6	2.42	2.23	4.39	134	25	23	45	
260	260	90	10	14	7	30	201	48.3	37.9	4820	371	9.99	317	47.7	2.56	2.36	4.66	146	25	50	50	
280	280	95	10	15	7.5	32	216	53.3	41.8	6260	448	10.9	399	57.2	2.74	2.53	5.02	160	25	50	50	
300	300	100	10	16	8	34	232	58.8	46.2	8030	535	11.7	495	67.8	2.90	2.70	5.41	174	28	55	55	
320	320	100	14	17.5	8.75	37	247	75.8	59.5	10870	679	12.1	597	80.6	2.81	2.60	4.82	182	28	58	58	
350	350	100	14	16	8	34	283	77.3	60.6	12870	734	12.9	570	75.0	2.72	2.40	4.45	204	28	58	58	
380	380	102	13.5	16	8	33	313	80.4	63.1	15760	829	14.0	615	78.7	2.77	2.38	4.58	227	28	60	60	
400	400	110	14	18	9	38	325	91.5	71.8	20350	1020	14.9	846	102	3.04	2.65	5.11	240	28	60	60	

چنانچه برای اندازه های زیادتری داده شده باشد باید توضیح مربوطه در صفحه ۳ مراعات شود.

در ۴۰x۲۰ ۵/۵ میلیمتر، ۵ میلیمتر است.

(**) پیچ های استاندارد شده برای اتصال های HV در اینجا بکار نمی رود.